



**AO3413**

**P-Channel Enhancement Mode Field Effect Transistor**

**General Description**

The AO3413/L uses advanced trench technology to provide excellent  $R_{DS(ON)}$ , low gate charge and operation with gate voltages as low as 1.8V. This device is suitable for use as a load switch or in PWM applications.

AO3413 and AO3413L are electrically identical.

-RoHS Compliant

-AO3413L is Halogen Free

**Features**

$V_{DS}$  (V) = -20V

$I_D$  = -3 A ( $V_{GS}$  = -4.5V)

$R_{DS(ON)} < 97m\Omega$  ( $V_{GS}$  = -4.5V)

$R_{DS(ON)} < 130m\Omega$  ( $V_{GS}$  = -2.5V)

$R_{DS(ON)} < 190m\Omega$  ( $V_{GS}$  = -1.8V)

ESD Rating: 250V HBM

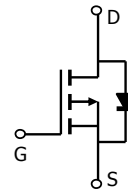
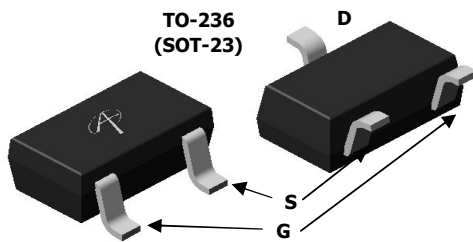

**Absolute Maximum Ratings**  $T_A=25^\circ\text{C}$  unless otherwise noted

Parameter	Symbol	Maximum	Units
Drain-Source Voltage	$V_{DS}$	-20	V
Gate-Source Voltage	$V_{GS}$	$\pm 8$	V
Continuous Drain Current <sup>A</sup>	$I_D$	$T_A=25^\circ\text{C}$	A
		$T_A=70^\circ\text{C}$	
Pulsed Drain Current <sup>B</sup>	$I_{DM}$	-15	
Power Dissipation <sup>A</sup>	$P_D$	$T_A=25^\circ\text{C}$	W
		$T_A=70^\circ\text{C}$	
Junction and Storage Temperature Range	$T_J, T_{STG}$	-55 to 150	$^\circ\text{C}$

**Thermal Characteristics**

Parameter	Symbol	Typ	Max	Units
Maximum Junction-to-Ambient <sup>A</sup>	$R_{\theta JA}$	70	90	$^\circ\text{C/W}$
Maximum Junction-to-Ambient <sup>A</sup>		Steady-State	100	125
Maximum Junction-to-Lead <sup>C</sup>	$R_{\theta JL}$	63	80	$^\circ\text{C/W}$

Electrical Characteristics (T<sub>J</sub>=25°C unless otherwise noted)

Symbol	Parameter	Conditions	Min	Typ	Max	Units
<b>STATIC PARAMETERS</b>						
BV <sub>DSS</sub>	Drain-Source Breakdown Voltage	I <sub>D</sub> =-250μA, V <sub>GS</sub> =0V	-20			V
I <sub>DSS</sub>	Zero Gate Voltage Drain Current	V <sub>DS</sub> =-16V, V <sub>GS</sub> =0V T <sub>J</sub> =55°C			-1 -5	μA
I <sub>GSS</sub>	Gate-Body leakage current	V <sub>DS</sub> =0V, V <sub>GS</sub> =±8V			±100	nA
V <sub>GS(th)</sub>	Gate Threshold Voltage	V <sub>DS</sub> =V <sub>GS</sub> , I <sub>D</sub> =-250μA	-0.3	-0.55	-1	V
I <sub>D(ON)</sub>	On state drain current	V <sub>GS</sub> =-4.5V, V <sub>DS</sub> =-5V	-15			A
R <sub>DS(ON)</sub>	Static Drain-Source On-Resistance	V <sub>GS</sub> =-4.5V, I <sub>D</sub> =-3A T <sub>J</sub> =125°C		81	97	mΩ
		V <sub>GS</sub> =-2.5V, I <sub>D</sub> =-2.6A		108	130	
		V <sub>GS</sub> =-1.8V, I <sub>D</sub> =-1A		146	190	mΩ
g <sub>FS</sub>	Forward Transconductance	V <sub>DS</sub> =-5V, I <sub>D</sub> =-3A	4	7		S
V <sub>SD</sub>	Diode Forward Voltage	I <sub>S</sub> =-1A, V <sub>GS</sub> =0V		-0.78	-1	V
I <sub>S</sub>	Maximum Body-Diode Continuous Current				-2	A
<b>DYNAMIC PARAMETERS</b>						
C <sub>iss</sub>	Input Capacitance	V <sub>GS</sub> =0V, V <sub>DS</sub> =-10V, f=1MHz		540		pF
C <sub>oss</sub>	Output Capacitance			72		pF
C <sub>rss</sub>	Reverse Transfer Capacitance			49		pF
R <sub>g</sub>	Gate resistance	V <sub>GS</sub> =0V, V <sub>DS</sub> =0V, f=1MHz		12		Ω
<b>SWITCHING PARAMETERS</b>						
Q <sub>g</sub>	Total Gate Charge	V <sub>GS</sub> =-4.5V, V <sub>DS</sub> =-10V, I <sub>D</sub> =-3A		6.1		nC
Q <sub>gs</sub>	Gate Source Charge			0.6		nC
Q <sub>gd</sub>	Gate Drain Charge			1.6		nC
t <sub>D(on)</sub>	Turn-On Delay Time	V <sub>GS</sub> =-4.5V, V <sub>DS</sub> =-10V, R <sub>L</sub> =3.3Ω, R <sub>GEN</sub> =3Ω		10		ns
t <sub>r</sub>	Turn-On Rise Time			12		ns
t <sub>D(off)</sub>	Turn-Off Delay Time			44		ns
t <sub>f</sub>	Turn-Off Fall Time			22		ns
t <sub>rr</sub>	Body Diode Reverse Recovery Time	I <sub>F</sub> =-3A, dI/dt=100A/μs		21		ns
Q <sub>rr</sub>	Body Diode Reverse Recovery Charge	I <sub>F</sub> =-3A, dI/dt=100A/μs		7.5		nC

A: The value of R<sub>θJA</sub> is measured with the device mounted on 1in<sup>2</sup> FR-4 board with 2oz. Copper, in a still air environment with T<sub>A</sub>=25°C. The value in any given application depends on the user's specific board design. The current rating is based on the t ≤ 10s thermal resistance rating.

B: Repetitive rating, pulse width limited by junction temperature.

C: The R<sub>θJA</sub> is the sum of the thermal impedance from junction to lead R<sub>θJL</sub> and lead to ambient.

D: The static characteristics in Figures 1 to 6,12,14 are obtained using <300 μs pulses, duty cycle 0.5% max.

E: These tests are performed with the device mounted on 1 in<sup>2</sup> FR-4 board with 2oz. Copper, in a still air environment with T<sub>A</sub>=25°C. The SOA curve provides a single pulse rating.

Rev 8: Aug 2008

THIS PRODUCT HAS BEEN DESIGNED AND QUALIFIED FOR THE CONSUMER MARKET. APPLICATIONS OR USES AS CRITICAL COMPONENTS IN LIFE SUPPORT DEVICES OR SYSTEMS ARE NOT AUTHORIZED. AOS DOES NOT ASSUME ANY LIABILITY ARISING OUT OF SUCH APPLICATIONS OR USES OF ITS PRODUCTS. AOS RESERVES THE RIGHT TO IMPROVE PRODUCT DESIGN, FUNCTIONS AND RELIABILITY WITHOUT NOTICE.

TYPICAL ELECTRICAL AND THERMAL CHARACTERISTICS

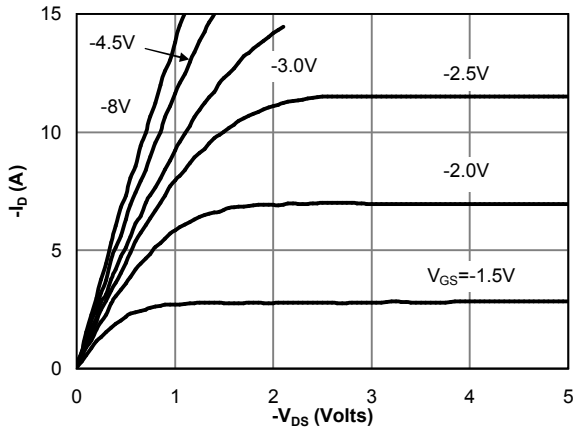

Fig 1: On-Region Characteristics

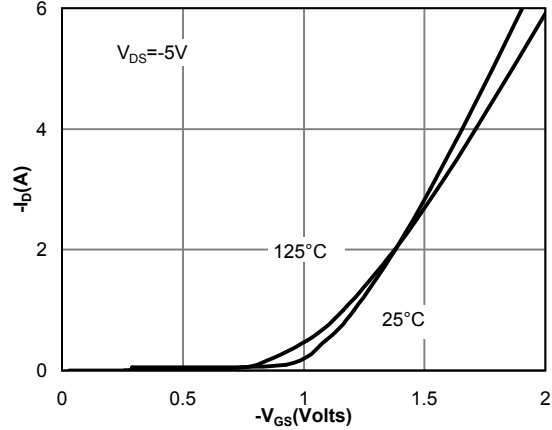

Figure 2: Transfer Characteristics

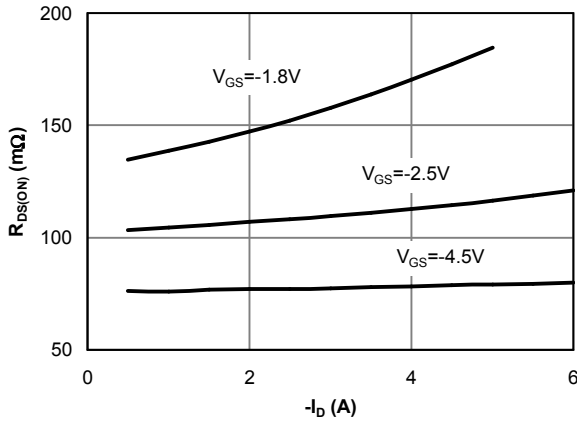

Figure 3: On-Resistance vs. Drain Current and Gate Voltage

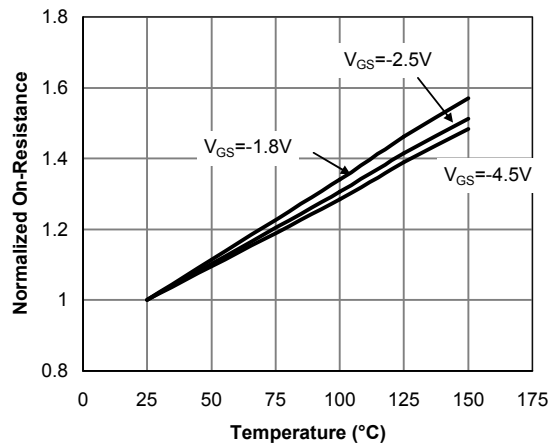

Figure 4: On-Resistance vs. Junction Temperature

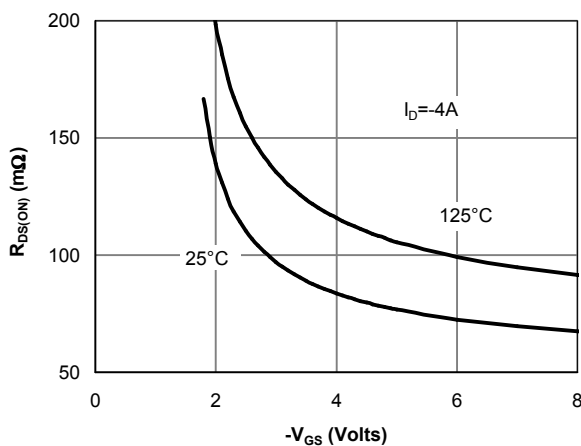

Figure 5: On-Resistance vs. Gate-Source Voltage

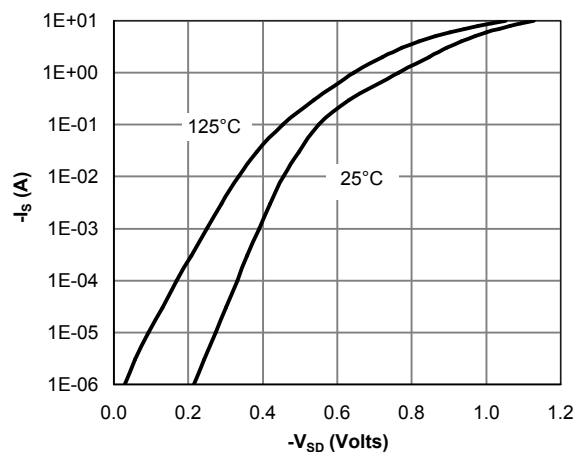

Figure 6: Body-Diode Characteristics

TYPICAL ELECTRICAL AND THERMAL CHARACTERISTICS

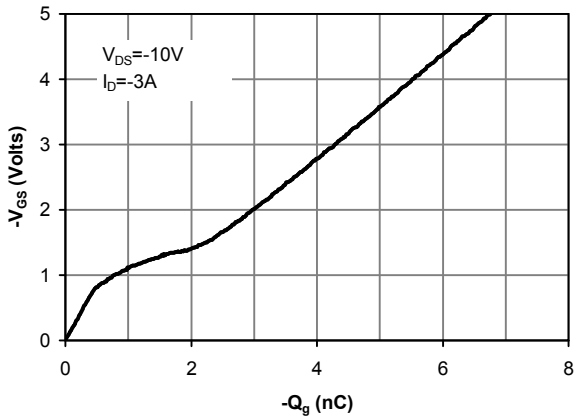

Figure 7: Gate-Charge Characteristics

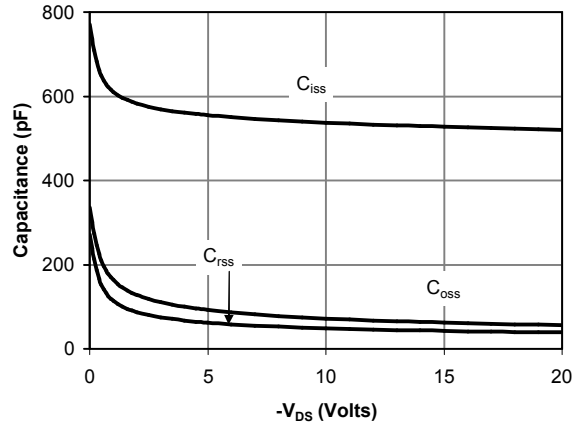

Figure 8: Capacitance Characteristics

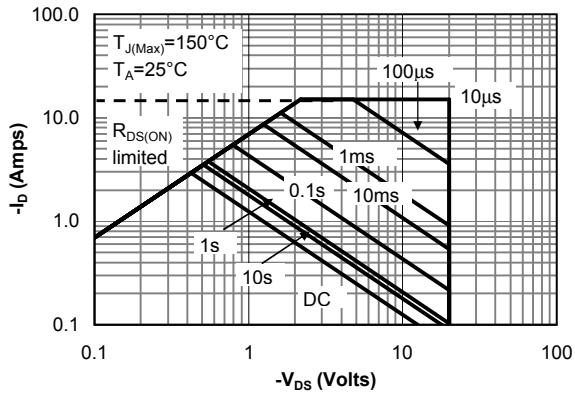

Figure 9: Maximum Forward Biased Safe Operating Area (Note E)

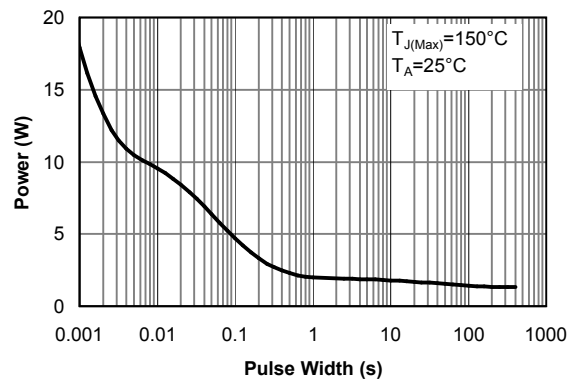

Figure 10: Single Pulse Power Rating Junction-to-Ambient (Note E)

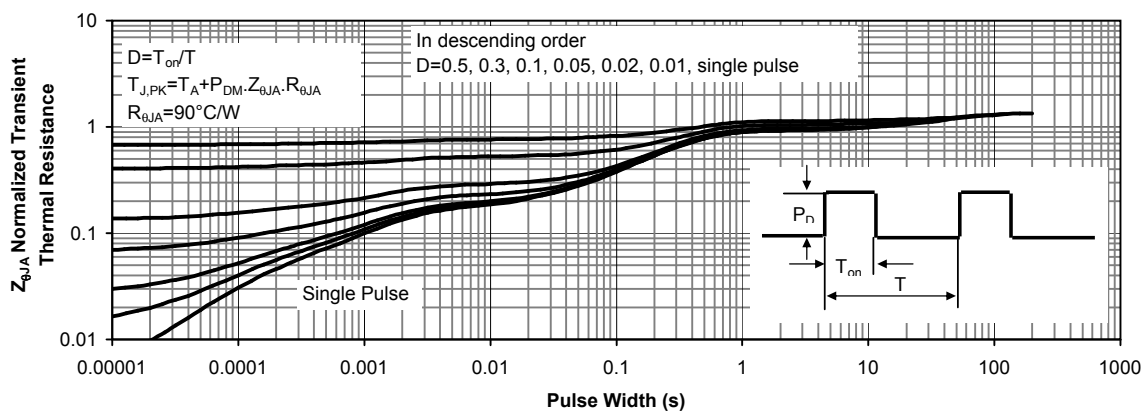
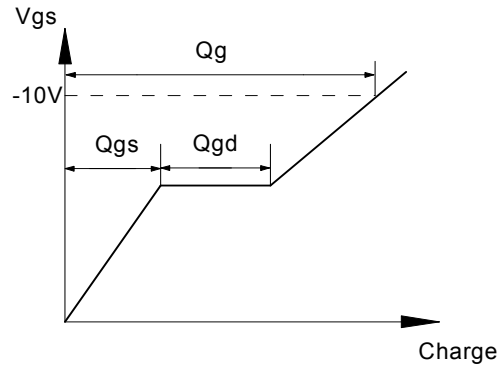
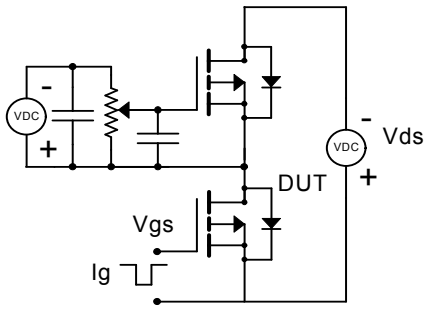
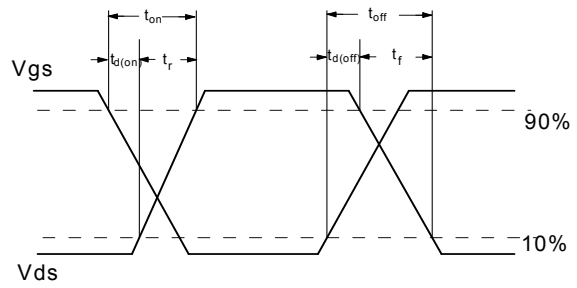
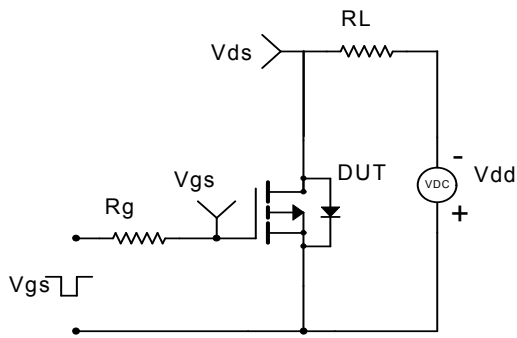

Figure 11: Normalized Maximum Transient Thermal Impedance

Gate Charge Test Circuit & Waveform



Resistive Switching Test Circuit & Waveforms



Diode Recovery Test Circuit & Waveforms

